



This manual contains safety information that if ignored can endanger life or result in serious injury. They are indicated by this icon.



Keep the instrument protected from sun and water. Avoid water splashes.



OPERATING INSTRUCTIONS FOR "LDPHRH" INSTRUMENT SERIES

with data logger software quick guide

Read Carefully !



ENGLISH Version

R1-07-10



“LDPHRH” instrument complies with the following European regulations:

EN60335-1 : 1995, EN55014, EN50081-1/2, EN50082-1/2, EN6055-2, EN60555,3

Based on directive CEE 73/23 c 93/68 (DBT Low voltage directive) and directive 89/336/CEE (EMC Electromagnetic Compatibility)



GENERAL SAFETY GUIDELINES

Danger!

In emergencies the instrument should be switched off immediately! Disconnect the power cable from the power supply!

When installing always observe local regulations!

Manufacturer is not liable for any unauthorized use or misuse of this product that may cause injury, damage to persons and / or materials.

Caution!

Instrument must be accessible at all times for both operating and servicing. Access must not be obstructed in any way!

Feeder should be interlocked with a no-flow protection device to automatically shut-off the pumps when there is no flow!

Pumps and accessories must be serviced and repaired by qualified and authorized personnel only!

Always discharge the liquid end before servicing the instrument!

Empty and rinse the liquid end before work on a pump which has been used with hazardous or unknown chemicals!

Always read chemical safety datasheet!

Always wear protective clothing when handling hazardous or unknown chemicals!

Instrument must be operated / serviced by trained technicians only!

All connection operations must be performed while the instrument is not connected to main supply!

1. Introduction

LDPHRH is a digital microprocessor based pH & ORP controller with temperature reading. Main working modes are: On/Off, PWM proportional and PWM fixed.

Working ranges are: pH: from 0 to 14pH ORP: from 0 to 999 mV.

All information are provided through a large backlit LCD display. Using a revolutionary wheel control the instrument can be easily programmed. LDPHRH is housed in a IP65 plastic box.

INPUTS:

- Stand-by
- Flow
- pH (+) level
- pH (-) level
- ORP level
- pH probe
- ORP probe
- Temperature probe

OUTPUTS:

- 2 relay outputs (pH and mV)
- 3 opto coupled pulses outputs (pH and mV)
- Main alarm

2. The wheel

Located in the upper right side of LDPHRH there is a wheel that must be used to control the instrument. Wheel can be rotated in both directions to scroll over the menus and / or pressed to confirm highlighted selection / value.

NOTE: Once changes are made press "OK" to save and exit from submenu. Press "ESC" to exit without saving.



Rotate wheel to scroll through menus or options

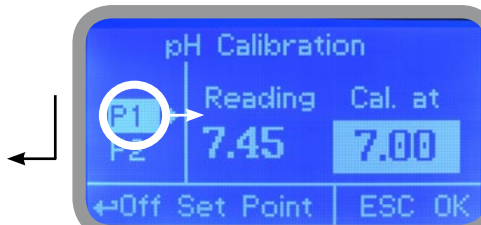

Press wheel to select highlighted option

3. Mainboard Connections

Unplug instrument from main power supply then perform connections by following the above picture.

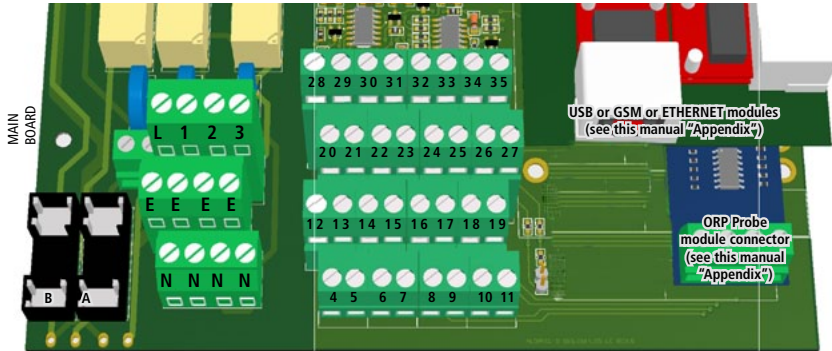
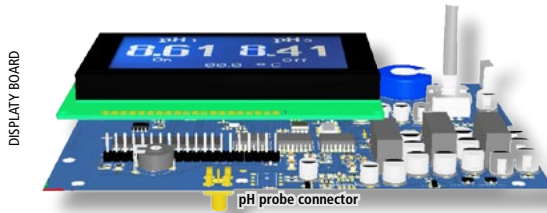

A: Main Fuse (6A T)

B: Outputs Fuse (3.15A T)

L(Live) - E (Earth) - N (Neutral): 85÷264VAC - 50/60 Hz

1(Live) - E(Earth) - N(Neutral): 85÷264VAC - 50/60 Hz Relay 1 Output "RELAY PH-2". To use with ON/OFF or PWM device

2(Live) - E(Earth) - N(Neutral): 85÷264VAC - 50/60 Hz Relay 2 Output "RELAY MV-2". To use with ON/OFF or PWM device

3(Live) - E(Earth) - N(Neutral) : 85÷264VAC Alarm output

29(-) - 28(+): Current output mA1 for pH

29(-) - 30(+): Current output mA2 for pH

32(-) - 31(+): Current output mA3 (n/a)

32(-) - 33(+): Current output mA4 for temperature

35(-) - 34(+): Pulse Sender Water Meter

20(-) - 21(+): Opto coupled output "PULSE PH-3". To use with "IS" or "MF" series dosing pumps

22(-) - 23(+): Opto coupled output "PULSE MV-1". To use with "IS" or "MF" series dosing pumps

24(-) - 25(+): Opto coupled output "PULSE PH-1". To use with "IS" or "MF" series dosing pumps

19(GND) - 26(+RS485) - 27(-RS485): RS485

12(+ Brown) - 13(Black) - 14(- Blue) - 15(GND): Proximity sensor mod. "SEPR"

9(-) - 8(+): Standby contact

9(-) - 10(+): ORP Level contact

17(-) - 16(+): pH Level 1 contact

17(-) - 18(+): pH Level 2 contact

4(Green) - 5(Brown) - 6(White) - 7(Yellow): PT100 temperature probe

Warning: Connections must be performed by qualified and trained personnel only.

4. Main Screen

When into normal operating mode, LDPHRH shows the following main screen:



Main screen zones:

(1) UNITS

“pH” is the measuring unit for pH probe.

“mV” is the measuring unit for ORP probe.

(2) VALUES

These numbers are values read by the probes.

(3) OUTPUTS STATUS

These fields are related to current outputs status and instrument activity.

For more information rotate the wheel when into main screen. (see next page)

WARNING MESSAGE NOTIFICATION AREA

During critical situations a warning / alarm message may appear. To in-depth explanation **completely rotate clockwise** the wheel to review main instrument parameters and current outputs status.

Note: the word “PUMP” as shown into this manual refers to a “dosing device” connected to the instrument!

5. Quick status check

From main screen **completely rotate clockwise** the wheel to review main instrument parameters and current outputs status.

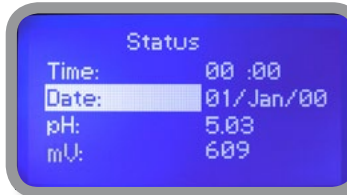

Local Time
Local Date
pH probe reading
ORP probe reading



Temperature probe reading
Dosing alarm condition
Probe failure status
Alarm contact status

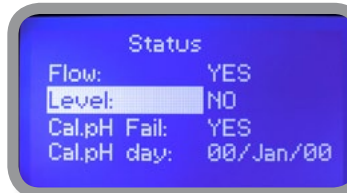

Flow contact status (SEPR)
Tank Level 1 status
Last pH calibration result
Last pH calibration date

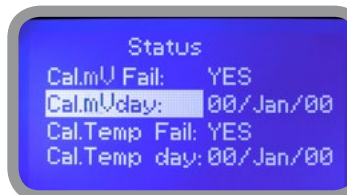

Last ORP calibration result
Last ORP calibration date
Last Temp. calibration result
Last Temp. calibration date

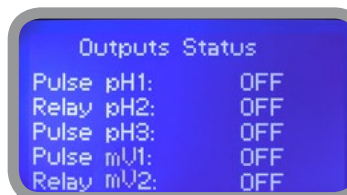

Outputs Status
See mainboard (page 4) for related connetions.

6. Password

To grant access into "Main Menu" press the wheel from main screen and enter the passcode. If this is the first time here then the passcode is 0000 (factory preset). Press wheel 5 times to enter into "Main Menu". Otherwise press the wheel 1 time and enter the passcode. Numbers can be selected rotating the wheel.

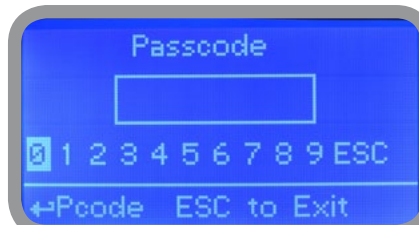
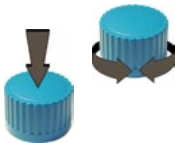
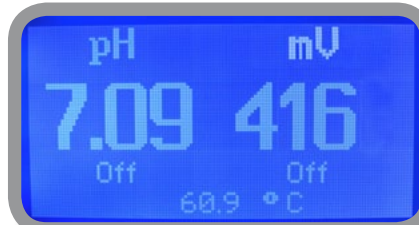

To set a new passcode choose "PARAMETERS" from "Main Menu", move on "New Pcode", click on wheel and enter a four numbers code. Click on "EXIT" and choose "YES" to save request. The new passcode is now ready.

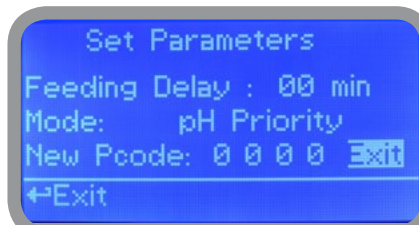
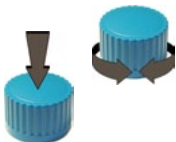

Lost passcode ?

Please don't forget the passcode (if changed). In the unfortunate event, please call your local distributor for unlocking procedure. There is no way for you to recover lost passcode.

7. "Main Menu" list

To grant access into "Main Menu" enter the passcode (as described in previous chapter). Once into "Main Menu" rotate the wheel to scroll through all the options available.

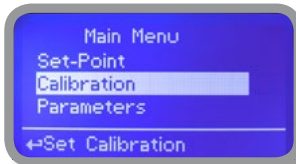

Setpoint (see page 9)
Calibration (see page 18)
Parameters (see page 22)



Output manager (see page 23)
Instrument reset (see page 24)
Dosing alarm (see page 25)

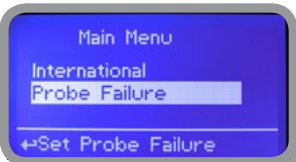

International (see page 26)
Probe Failure (see page 27)



Flow (see page 28)
Service (see page 28)



Log Setup (see page 29)
RS485 Setup (see page 29)
Out of Range Alarm (see page 31)

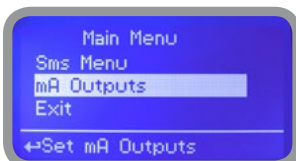

SMS menu (see page 34)
mA Outputs*** (see page 30)
Exit (to main screen)

***This menu is available on current outputs instrument version only

8. "Set-Point", pH working modes

For "PH-1" and "PH-3" outputs, setpoint can be set between **On/Off mode**, **Proportional (%) mode** or **disabled (OFF)**.
For "PH-2" output, setpoint can be set using **On/Off mode**, **Proportional PWM mode**, **Fixed PWM mode** or **disabled (OFF)**.

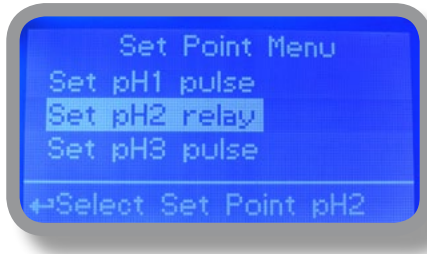

8.1 "Set-Point", pH (on/off)

This mode is valid for all pH related outputs. **On/Off mode** set the instrument to operate using two set values that enable or disable the pH pump. To use this mode move cursor on "Working Mode". Press the wheel and select it.

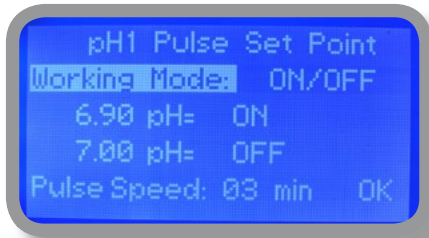
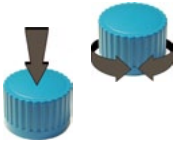

ON/OFF mode while dosing ALKALI

Set pH value at 7.00 OFF and 6.90 ON. Set Pulse Speed per minute (strokes per minute) based on dosing device capabilities.

Instrument will leave the pH pump active until reading value will increase up to 7.00pH.
At 7.00pH the pH pump will be disabled until reading value will decrease under 6.90pH.

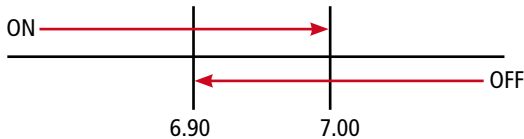

Pulse speed: to let pump operate at pulses per minutes add one or more minute (1pulse every xx minutes).

8.2 "Set-Point", pH (on/off)

This mode is valid for all pH related outputs. ON/OFF mode while dosing ACID

Set pH value at 7.00 OFF and 7.10 ON. Set Pulse Speed per minute (strokes per minute) based on dosing device capabilities.

Instrument will leave the pH pump active until reading value will decrease up to 7.00pH

At 7.00pH the pH pump will be disabled until reading value will increase up to 7.10pH.

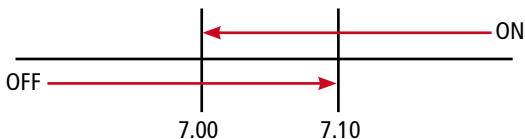

To end procedure move cursor on "OK" and press wheel to proceed to "Save" request screen. Move wheel on "YES" to save or "NO" to discard changes.

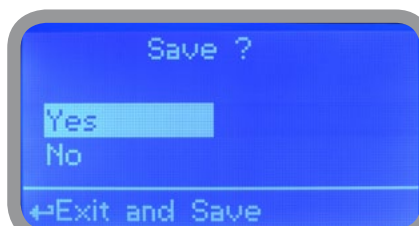

Did you know ?

In chemistry, an alkali is a basic, ionic salt of an alkali metal or alkaline earth metal element. Alkalis are best known for being bases (compounds with pH greater than 7) that dissolve in water. The adjective alkaline is commonly used in English as a synonym for base, especially for soluble bases. This broad use of the term is likely to have come about because alkalis were the first bases known to obey the Arrhenius definition of a base and are still among the more common bases. Since Brønsted-Lowry acid-base theory, the term alkali in chemistry is normally restricted to those salts containing alkali and alkaline earth metal elements.

An acid (often represented by the generic formula HA [H+A--]) is traditionally considered any chemical compound that, when dissolved in water, gives a solution with a hydrogen ion activity greater than in pure water, i.e. a pH less than 7.0. That approximates the modern definition of Johannes Nicolaus Brønsted and Martin Lowry, who independently defined an acid as a compound which donates a hydrogen ion (H+) to another compound (called a base). Common examples include acetic acid (in vinegar) and sulfuric acid (used in car batteries). Acid/base systems are different from redox reactions in that there is no change in oxidation state.

8.3 "Set-Point", pH (proportional)

This mode is valid for "PH-1" and "PH-3" outputs.



Proportional mode set the instrument to operate using a calculated percentage between two set values that enable or disable the pH pump. To use this mode move cursor on "Working Mode". Press the wheel and select it.

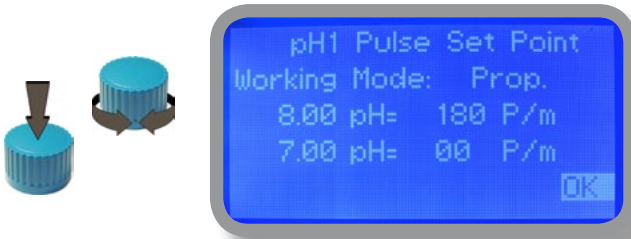

PROPORTIONAL mode between 7pH(0 P/m) and 8pH (180 P/m). p/m is : pulses per minute
In this mode the pH pump will be "ON" for values greater than 8pH with maximum set pulses per minute capacity (e.g.: 180) and it'll be "OFF" for values lower than 7pH. For values of 7.5pH pump will be "ON" with 90 pulses per minute capacity. The calculation is based on 180 pulses per minute setting (see page 22). To end procedure move cursor on "OK" and press wheel to proceed to "Save" request screen. Move wheel on "YES" to save or "NO" to discard changes.

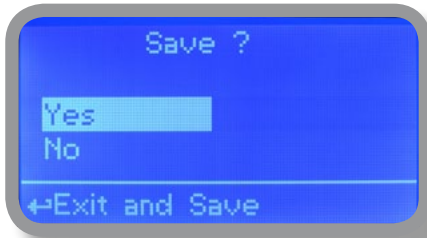

8.4 "PWM" (proportional), pH

This mode is valid for "PH-2" output only. Pulse-width modulation (PWM) of a signal or power source involves the modulation of its duty cycle, to either convey information over a communications channel or control the amount of power sent to a load.

This mode works over a settable (0 to 100 seconds) time to switch on or off selected output. During this time if reading value will move towards a set value (on or off) the PWM will operate the output on timered basis. Reaching the set value the PWM will permanently leave on or off the output.

Parameters to set for this mode are:

Unit Value + %: (time activity towards set value. 0% means 0 seconds. 100% means 100 seconds.)
pH range: two pH values within PWM operates.

For example: set first pH value at 8.00 = 100% and second pH value at 4.0 = 0%.

For reading values \geq to 8.00 the output will be permanently ON.

For reading values \leq 4.0 the output will be permanently OFF.

For reading value of 7.00 the output will be OFF for 25 seconds, ON for 75 seconds.

For reading value of 6.00 the output will be OFF for 50 seconds, ON for 50 seconds.

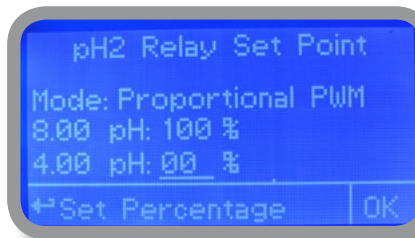

8.5 "PWM" (fixed), pH

This mode is valid for "PH-2" output only. Pulse-width modulation (PWM) of a signal or power source involves the modulation of its duty cycle, to either convey information over a communications channel or control the amount of power sent to a load. Using fixed mode is possible to set operating time to switch on or off selected output.

During this time if reading value will move towards a set value (on or off) the PWM will operate the output on timed basis. Reaching the set value the PWM will permanently leave on (for selected amount of time) or off the output.

Parameters to set for this mode are:

pH range: two pH values within PWM operates.

Ton: ON period, during output activity.

Toff: OFF period, during output activity.

For example: set first pH value (OFF) at 7.20.. Set second pH value (ON) at 8.00.

Set "working-pause" output activity with Toff 0 seconds and Ton 40 seconds.

For reading values \geq to 8.00 the output will be ON with activity based on Ton and Toff.

For reading values \leq 7.20 the output will be permanently OFF.

For reading values within working range operating mode is on HYSTERESIS base. Once reading value is 7.20 pH will be permanently off until it will reaches 8.00 pH.

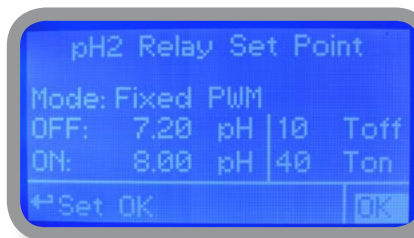

8.6 "Set-Point", ORP (On/Off)

"MV-1" output can be set to operate within: On/Off, Proportional (%) or disabled (OFF) modes.

"MV-2" output can be set to operate within: On/Off, Proportional PWM, Fixed PWM or disabled (OFF) modes.



8.7 "Set-Point", ORP (on/off)

All ORP outputs can be set to operate into this mode.

This mode enables ORP pump to operate between two On/Off values. Move wheel over "Working Mode" to select it.

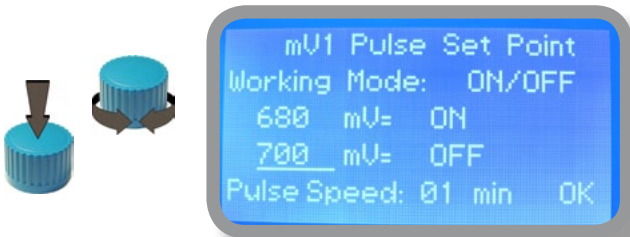

ON/OFF mode

Set ORP value at 680mV ON and 700mV OFF. The difference between the two ORP values is called HYSTERESIS.

Instrument will enable the ORP pump when reading value will decrease at 680mV

At 680mV the ORP pump will be enabled until reading value will increase at 700mV.

Pulse Speed: pulses per minute setting.

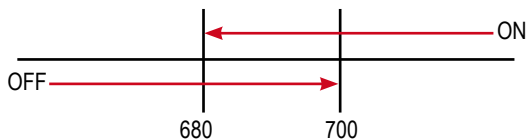

8.8 "Set-Point", ORP (proportional)

"MV-1" output can be set into this mode.



Proportional mode set the instrument to operate using a calculated percentage between two set values that enable or disable the ORP pump. To use this mode move cursor on "Working Mode". Press the wheel and select it.

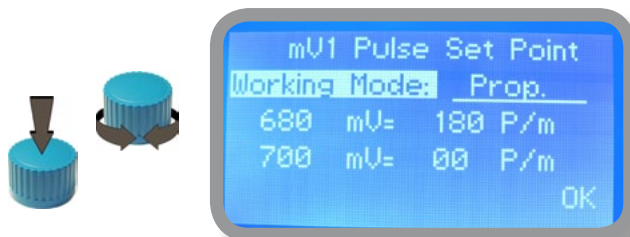

PROPORTIONAL MODE between 700(0 P/m) and 680 (180 P/m). [P/m: pulses per minute]

This mode operates ORP pump for a value lower than 680mV with maximum dosing capacity (180strokes) and it will stop ORP pump for a reading value higher than 700 mV.

A 690 mV reading value will operate ORP pump with a 90 strokes capacity calculated on strokes settings (see page 22). Pump will operate with 90 strokes dosing capacity. To end procedure move cursor on "OK" and press wheel. Choose "SAVE" to save setup or "NO" to discard changes.

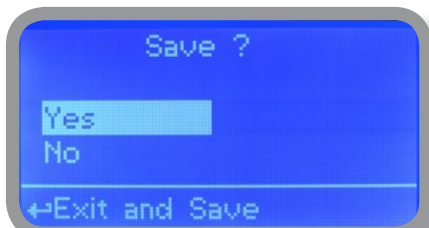

8.9 "PWM" Proportional, ORP

"MV-2" output can be set into this mode.

Pulse-width modulation (PWM) of a signal or power source involves the modulation of its duty cycle, to either convey information over a communications channel or control the amount of power sent to a load.

This mode works over a settable (0 to 100 seconds) time to switch on or off selected output.

Time resolution is 5 seconds, 5 steps. During this time if reading value will move towards a set value (on or off) the PWM will operate the output on timed basis. Reaching the set value the PWM will permanently leave on or off the output.

Parameters to set are:

Unit Value + %: (time activity towards set value. 0% means 0 seconds. 100% means 100 seconds.)

mV range: two pH value between PWM operates.

E.g: set first value at 700 = 00% and second value at 680=60%.

For reading values ≥ 700 output will always be OFF.

For reading values ≤ 680 output will be ON for 60 seconds and OFF for 40 seconds.

If reading value is 690 mV the output will be ON with a 30% of total set time. (ON for 30 seconds, OFF for 70 seconds).

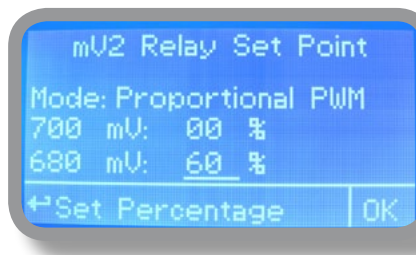

8.10 "PWM" (fixed), ORP

"MV-2" output can be set into this mode.

Pulse-width modulation (PWM) of a signal or power source involves the modulation of its duty cycle, to either convey information over a communications channel or control the amount of power sent to a load.

This mode works over a settable (0 to 100 seconds) time to switch on or off selected output.

Time resolution is 5 seconds, 5 steps. During this time if reading value will move towards a set value (on or off) the PWM will operate the output on timered basis. Reaching the set value the PWM will permanently leave on or off the output.

Parameters to set are:

mV range: two pH value between PWM operates.

Ton: "ON" time if output is active.

Toff: "OFF" time if output is active.

E.g.: set first mV value: (OFF) at 700 and second mV value: (ON) at 680.

Set "WORK-PAUSE" activity with Toff 0 seconds and Ton 80 seconds.

For reading values ≥ 700 output output will always be OFF.

For reading values ≤ 680 output will be ON within "WORK-PAUSE" mode based on Ton and Toff settings.

Within 700mV and 680mV values output activity will operate on HYSTERESIS basis. Once 700mV reading value will be reached the output will always be OFF up to 680mV reading value.

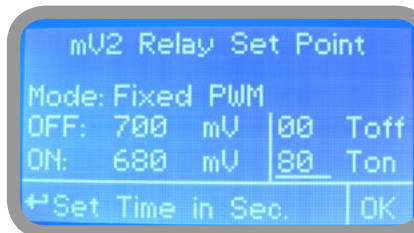

9. "Probe Calibration", pH

pH calibration procedure involves two calibration points and it requires two buffer solutions. Default buffer solutions are pH 4.00 and pH 7.00. pH reading value can be also compensated from "pH compensation" menu. From "Menu Calibration" choose "pH probe".

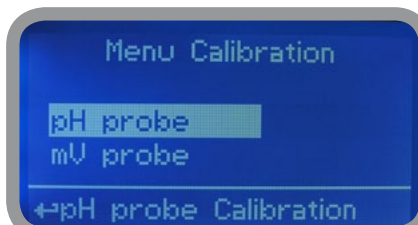

In the following example instrument will calibrate pH using default buffer solutions values.

Note: this procedure assumes that instrument is correctly configured and a working pH probe connected. Otherwise unattended results may occur.

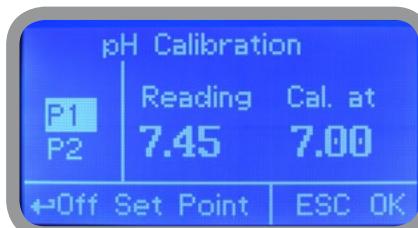
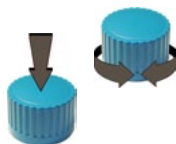

pH7

Calib 1st Point.

Once into "pH Calibration" menu move wheel on "P1" then press wheel to enter into first point calibration submenu. Prepare 7.00pH buffer solution and dip probe's sensor on it. Wait until reading value is stable and according to buffer solution value move wheel until it is the same on display ("Cal. at" field). Default value is 7.00pH. To end procedure move cursor on "OK" and press wheel to proceed to next step.

Note: buffer solution value may change if environment temperature it's different than 20°C. Read solution's label for more information. According to this occurrence "pH Default" must be changed.

9. "Probe Calibration", pH

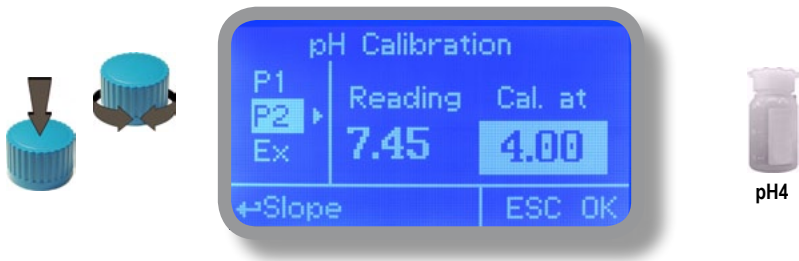

Calib 2nd Point.

Move wheel on "P2" then press wheel to enter into second point calibration submenu. Prepare 4.00pH buffer solution and dip probe's sensor on it. Wait until reading value is stable and according to buffer solution value move wheel until it is the same on display ("Cal. at" field). Default value is 4.00pH.

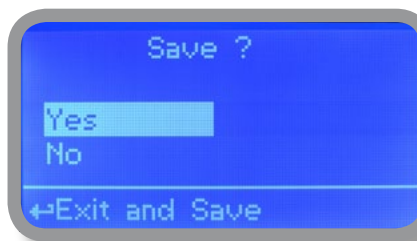

To end procedure move cursor on "OK" and press wheel to proceed to "Save" request screen. Move wheel on "YES" to save or "NO" to discard changes.

Note: buffer solution value may change if environment temperature it's different than 20°C. Read solution's label for more information. According to this occurrence "pH Default" must be changed.

9.1 "Probe Calibration", ORP

ORP calibration procedure involves probe's selection with one point (P1) calibration. From "Menu Calibration" choose "ORP probe".



Note: This procedure assumes that instrument is correctly configured and a working ORP probe connected and installed on system. Measurement must be performed using plant water. Otherwise unattended results may occur.

Calibration can be performed in two ways: the first by alignment with a buffer solution, the second by reading the residual ORP level of the pool with the DPD1, comparison with the attached graph followed by alignment of the pumps group. The choice of method is exclusively at the user's discretion. In both cases, to establish the set-point value, a check using the DPD1 or other analysis system is necessary. The enclosed graphs provide a reference between the mV value read by the pumps group and the quantity of residual ORP expressed in mg/litre, and are linked to the pH value.

- 1) Measure buffer solution temperature and verify that it is the same printed on solution's label.
- 2) Remove protective cap from probe and wash probe's tip into water. Then dry it by shaking the probe in air.
- 3) On LDPHRH set "Cal. at" value to match buffer solution value then put probe's tip into buffer solution and wait until LDPHRH shows a stable reading value (mV field).
- 4) Move cursor on "OK" and press wheel to confirm the new calibration value. If calibration process fails the instrument will show "CALIBRATION FAILED". Repeat procedure otherwise move on "ESC" and press wheel.

REDOX - mg FREE CHLORINE - pH GRAPHIC TABLE

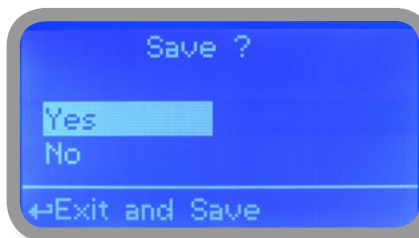
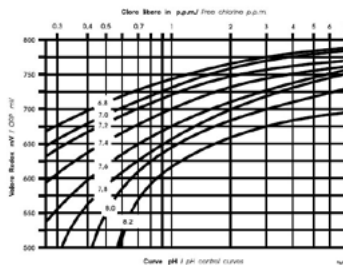

To end procedure move cursor on "OK" and press wheel to proceed to "Save" request screen. Move wheel on "YES" to save or "NO" to discard changes. If an error occurred during calibration procedure then the instrument will show an error message and will ask to proceed to a new calibration, cancel current operation or restore default settings.

9.2 "Probe Calibration", °C - Temperature

A professional thermometer is required to obtain a reliable calibration. From "Menu Calibration" choose "Temp probe".

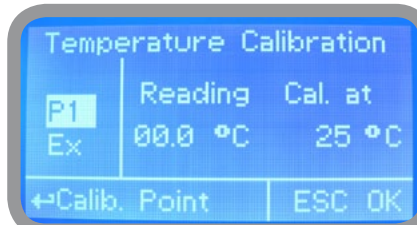

Note: This procedure assumes that instrument is correctly configured and properly connected to a working PT100. Calibrate using plant's temperature otherwise unattended results may occur.

Using an external thermometer read actual temperature and edit related field "Cal. at". Confirm by pressing wheel.

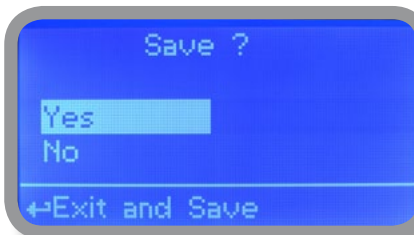

To end procedure move cursor on "OK" and press wheel to proceed to "Save" request screen. Move wheel on "YES" to save or "NO" to discard changes. If an error occurred during calibration procedure then the instrument will show an error message and will ask to proceed to a new calibration, cancel current operation or restore default settings.

10. "Parameters"

From "Menu Calibration" choose "Parameters". This menu allows to set a delay (max 60 minutes) before pumps begin to feed. Furthermore use this menu to set pH pump startup priority and to change default passcode.



Feeding Delay.

Move on "Feeding Delay" then press wheel. Choose a value between 0 (disabled) and 60 minutes (maximum delay time). This feature can be used to accord a startup delay for the pumps. Delay occurs when instrument is powered or after a "NO FLOW" contact recovery.

Mode.

Move on "Mode" then press wheel. If both pumps need to operate, a startup priority can be set to allow the pH pump to begin to feed prior to ORP pump. Choose "pH priority" to enable this function. ORP pump will begin to dose when pH pump has stopped.

New Pcode.

See page 10.

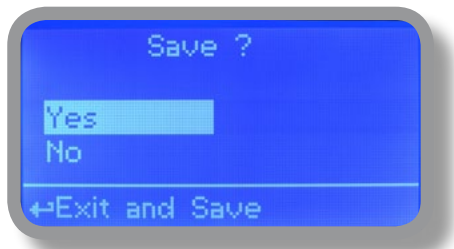

To end procedure move cursor on "OK" and press wheel to proceed to "Save" request screen. Move wheel on "YES" to save or "NO" to discard changes.

11. "Output Manager"

From "Menu Calibration" choose "Output Manager". This menu allows to manually operate all outputs for a settable time. Set to "AUTO" for normal operating mode. Set to "OFF" to permanently disable outputs.



Press wheel to move cursor on "TIME" field. Once here, choose a working time between 0 (disabled) or 199 minutes. Move on "EXIT", then press wheel.

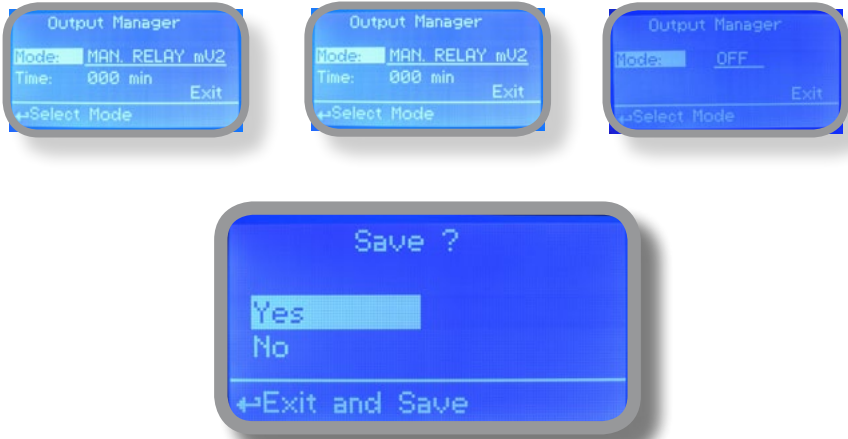

Choose "YES" to save changes. Exit from main menu. Main display will show a countdown for selected output. To stop this countdown go back to "Output Manager" menu and choose "AUTO" as working mode or wait until countdown ends. **This function can be used for priming purposes.**

12. "Instrument Reset"

To restore instrument to its default values (including password) once into "Instrument Reset" menu, press wheel then change value to "ON", press wheel again, move on "OK" then finally press wheel. The instrument display will show "CHECKSUM ERROR". Press wheel to return into "Main Menu". Move on "EXIT", then press wheel. The instrument is now restored to factory default. Please repeat all calibration procedures and programming parameters.



13. "Dosing Alarm"

Use this menu to assign a maximum time to the pumps for reaching the setpoint. If set time ends and the pumps are still dosing, within this menu is possible to STOP them or just to show an alarm message. Function can be disabled selecting "OFF" instead of a number (minutes). Dosing alarm can be set for both or just one pump.

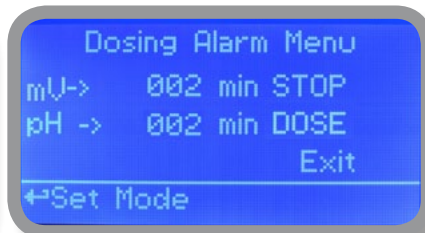
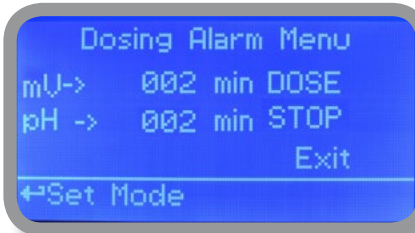

E.g. To set ORP pump to stop after time ends and setpoint isn't still reached press wheel, choose maximum time, press wheel move on next field and choose "STOP". Time can be set between 0 and 100 minutes. When satisfied with settings move on exit and press wheel.

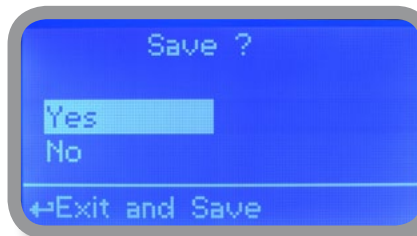

To end procedure move cursor on "OK" and press wheel to proceed to "Save" request screen. Move wheel on "YES" to save or "NO" to discard changes.

14. "International"

Use this menu to set international parameters as UNIT FORMAT (Europe IS or USA), Local Time and Date.

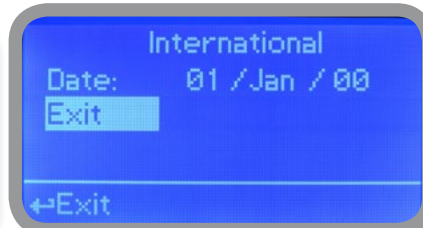
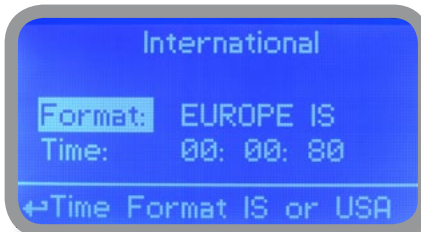

Format.

Use this option to use European or USA units format. See table for differences.

EUROPE IS (International Standard)	USA
Date (DD/MMM/YY)	Date (MMM/DD/YY)
Time 24h	Time AM / PM

Time.

Use this option to set local time.

Date.

Use this option to set date.

Move on exit to end changes.

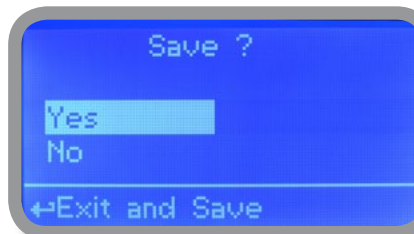

To end procedure move cursor on "OK" and press wheel to proceed to "Save" request screen. Move wheel on "YES" to save or "NO" to discard changes.

15. "Probe Failure"

Use this menu to assign a maximum time for connected probes to stay in "stuck" condition. A stuck probe (it remains on same reading value for some time) means that probably probe itself is damaged. Within this menu is possible to STOP pumps or just to show an alarm message (probe failure) . Function can be disabled selecting "OFF" instead of a number (minutes). This function can be set for both or just one probe.

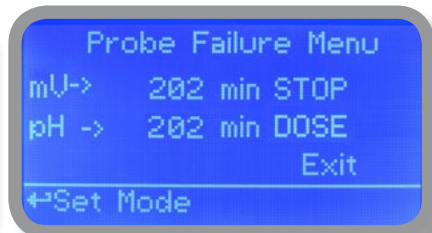
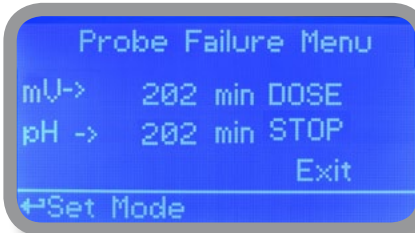

E.g. To set ORP pump to stop after time ends and probe doesn't change reading values press wheel, choose maximum time, press wheel move on next field and choose "STOP". Time can be set between 100 and 254 minutes. When satisfied with settings move on exit and press wheel.



To end procedure move cursor on "OK" and press wheel to proceed to "Save" request screen. Move wheel on "YES" to save or "NO" to discard changes.

16. "Flow Contact"

Flow contact (see "SEPR" blocks on page 4) can be enabled to stop a dosing procedure using a N.O. contact mode (normally open) or N.C. contact mode (normally closed) when status on blocks changes. Rotate wheel to choose between: "DISABLE", "REVERSE" (N.O. contact) or "DIRECT" (N.C. contact).

Furthermore "Flow contact" can starts after a specified time when contact status changes. To set it move wheel on "Time:00 min", click it and rotate to choose time (from 0 to 99 minutes). Confirm selection by clicking wheel.

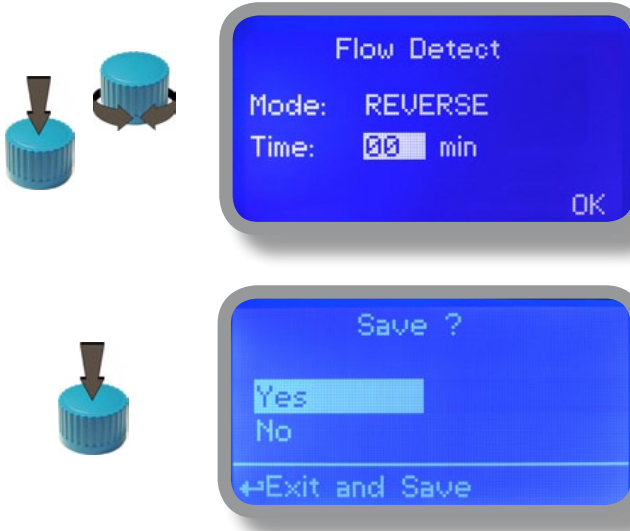

To end procedure move cursor on "OK" and press wheel to proceed to "Save" request screen. Move wheel on "YES" to save or "NO" to discard changes.

17. "Service"

This "view only" menu shows probes reading live. Press "ESC" to exit.



18. "Log Setup"

Log setup stores instrument activities when an alarm (flow, level, out of range reading, etc.) occurs.



Log activity recording can be started by moving wheel on "Mode: Disable" and changing it to "Mode: Enable". Log activity starting time can be set to begin at specified time by entering "Time". Activities data are collected every specified hour or minutes. Edit this parameter by moving wheel on "Every: 00:00" and changing it to desired time.

ID and Station Name as appears on a received SMS from instrument



19. "RS485 Setup"

Prior to use advanced communication functions (e.g.: SMS alarm service or remote communication) the instrument must have a unique ID NUMBER (move wheel on "OK" to check it) and ID NAME (station name). Rotate wheel and edit fields. If ID number has already assigned an error message will follow. In this occurs try using another number.



20. "mA Outputs"

This menu allows to configure mA current outputs for pH, ORP and Temperature channels. Options to set are:

MODE (selectable between 0-20 or 4-20 mA current output)

Max mA: maximum probe's reading value at 20 mA current

Min mA: minimum probe's reading value at 0 or 4 mA current

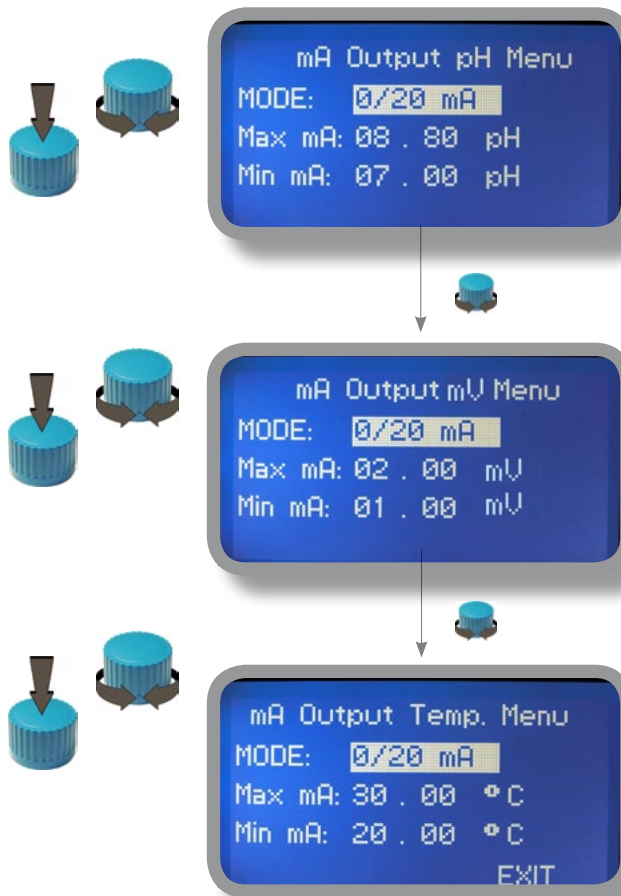

Rotate wheel to move within all 3 channels. Click wheel to select parameter and rotate wheel to change it. Click wheel again and rotate wheel to move cursor on next parameter. To end procedure move cursor on "EXIT" and press wheel to proceed to "Save" request screen. Move wheel on "YES" to save or "NO" to discard changes.

This menu is available only for "LDPHxx" instrument series with current outputs option enabled.

21. "Out of range alarm"

"Out of range alarm" menu defines the minimum and maximum pH and ORP probe read value before to stop dosing activity and to show an alarm message.



Move wheel on "Min/Max pH Range" to set "out of range" condition for pH probe then click on wheel to enter into "Min/Max Range menu".

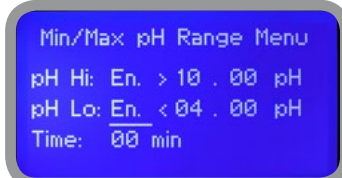

Move wheel on "pH Hi: Dis." and change status from "Dis." (option disabled) to "En." (option enabled) by clicking on wheel and rotating it. Press wheel again and move on next field. Press wheel and enter a value for HIGH alarm.

Repeat procedure for "pH Lo: Dis." and enter a value for LOW alarm.

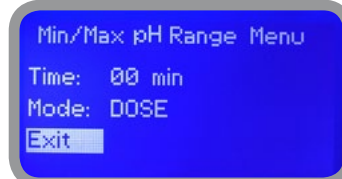

As last option enter "Time" (max 99 minutes) after which if lower or higher read value condition stays then the alarm occurs (to set into mode field).

To change alarm mode move wheel on "Mode", press it and choose between "DOSE" (connected pumps will not stop dosing activity when read value is out of range) or "STOP" (connected pumps will stop dosing activity when read value is out of range and an alarm message is displayed).



Move wheel on "Min/Max mV Range" to set "out of range" condition for ORP probe then click on wheel to enter into "Min/Max Range menu".

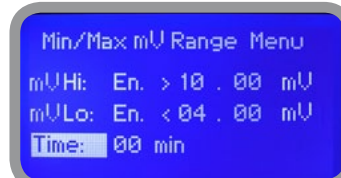

Move wheel on "mV Hi: Dis." and change status from "Dis." (option disabled) to "En." (option enabled) by clicking on wheel and rotating it. Press wheel again and move on next field. Press wheel and enter a value for HIGH alarm.

Repeat procedure for "mV Lo: Dis." and enter a value for LOW alarm.

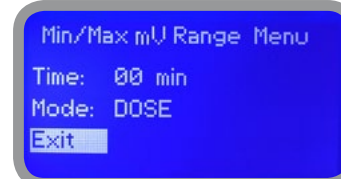

As last option enter "Time" (max 99 minutes) after which if lower or higher read value condition stays then the alarm occurs (to set into mode field).

To change alarm mode move wheel on "Mode", press it and choose between "DOSE" (connected pumps will not stop dosing activity when read value is out of range) or "STOP" (connected pumps will stop dosing activity when read value is out of range and an alarm message is displayed).

22. Technical information.

Power supply: 85÷264 VAC
 pH range: 0 ÷ 14 ; ORP range: 0 ÷ 999 mV
 Environment Temperature: -10 ÷ 45°C (14 ÷ 113°F)
 Chemical Temperature: 0 ÷ 50°C (32 ÷ 122°F)
 Installation Class: II
 Pollution Level: 2
 Packaging and Transporting Temperature: -10 ÷ 50°C (14 ÷ 122°F)
 Protection degree: IP 65

Product	Formula	Ceram.	PVDF	PP	PVC	SS 316	PMMA	Hastel.	PTFE	FPM	EPDM	NBR	PE
Acetic Acid, Max 75%	CH3COOH	2	1	1	1	1	3	1	1	3	1	3	1
Hydrochloric Acid, Concentrate	HCl	1	1	1	1	3	1	1	1	1	3	3	1
Hydrofluoric Acid 40%	H2F2	3	1	3	2	3	3	2	1	1	3	3	1
Phosphoric Acid, 50%	H3PO4	1	1	1	1	2	1	1	1	1	1	3	1
Nitric Acid, 65%	HNO3	1	1	2	3	2	3	1	1	1	3	3	2
Sulphuric Acid, 85%	H2SO4	1	1	1	1	2	3	1	1	1	3	3	1
Sulphuric Acid, 98.5%	H2SO4	1	1	3	3	3	3	1	1	1	3	3	3
Amines	R-NH2	1	2	1	3	1	-	1	1	3	2	3	1
Sodium Bisulphite	NaHSO3	1	1	1	1	2	1	1	1	1	1	1	1
Sodium Carbonate (Soda)	Na2CO3	2	1	1	1	1	1	1	1	2	1	1	1
Ferric Chloride	FeCl3	1	1	1	1	3	1	1	1	1	1	1	1
Calcium Hydroxide (Slaked Lime)	Ca(OH)2	1	1	1	1	1	1	1	1	1	1	1	1
Sodium Hydroxide (Caustic Soda)	NaOH	2	1	1	1	1	1	1	1	2	1	2	1
Calcium Hypochlor.(Chlor.ted Lime)	Ca(OCl)2	1	1	1	1	3	1	1	1	1	1	3	1
Sodium Hypochlorite, 12.5%	NaOCl + NaCl	1	1	2	1	3	1	1	1	1	1	2	2
Potassium Permanganate, 10%	KMnO4	1	1	1	1	1	1	1	1	1	1	3	1
Hydrogen Peroxide, 30% (Perydrol)	H2O2	1	1	1	1	1	3	1	1	1	2	3	1
Aluminium Sulphate	Al2(SO4)3	1	1	1	1	1	1	1	1	1	1	1	1
Copper-II-Sulphate (Roman Vitriol)	CuSO4	1	1	1	1	1	1	1	1	1	1	1	1

Resistance rating: (1: Resistant) ; (2: Fairly resistant) ; (3: Not resistant)

Polyvinylidene fluoride (PVDF) Pump Heads, valves, fitting, tubing

Polypropylene (PP) Pump Heads, valves, fitting, level floater

PVC Pump Heads

Stainless steel (SS 316) Pump Heads, valves

Polymethyl Metacrilate (Acrylic) PMMA Pump Heads

Hastelloy C-276 Injection valve spring

Polytetrafluoroethylene (PTFE) Diaphragm

Fluorocarbon (Viton® B) Sealings

Ethylene propylene (EPDM) Sealings

Nitrile (NBR) Sealings

Polyethylene (PE) Tubing

23. SEPR configuration

SEPR "Flow Sensor" configuration for two instruments

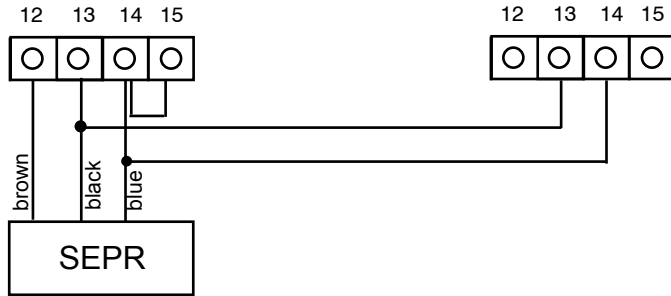

Configuration of a Flow Switch with a voltage free contact and two instruments

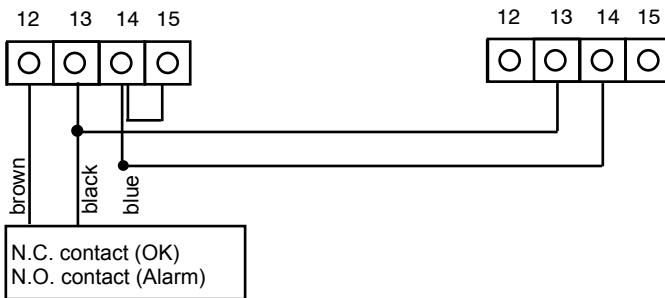

Appendix A - "SMS/GSM module"

Located under mainboard cover there is a four pins connector that can be used to install USB, ETHERNET or MODEM modules. Modules come pre-installed upon request and may appear different as shown (different configurations). **"SMS/GMS module" can be configured to send SMS messages containing critical instrument information.**

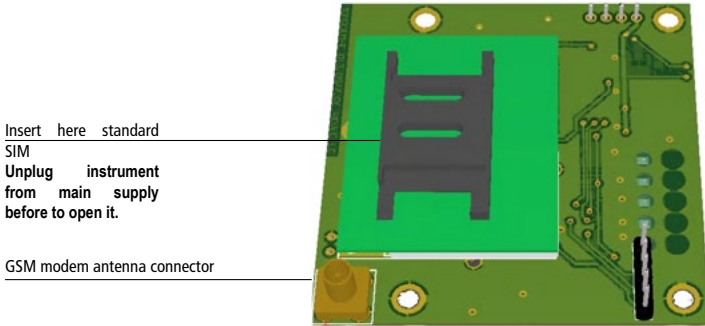

Insert here standard
SIM
Unplug instrument
from main supply
before to open it.

GSM modem antenna connector

To obtain reliable results with this feature please check the following list:

- Make certain the antenna location is not shielded by metal objects or near sources of electrical 'noise'.
- Do not route the cable where it could be pinched in doors, windows etc.
- Secure the antenna cable
- Ensure that SIM into "SMS/GSM module" is properly inserted, activated and within operator range.
- Set instrument ID / NAME from "RS485 Setup" menu (see page 28) and configure "Out of Range Alarm" menu (see page 30).

Within "Main menu" select "SMS MENU" to enable SMS service and enter SMS receiver phone numbers.



Up to three numbers for sending SMS can be stored into LDPHRH memory. SMS recipient will receive an SMS containing instrument ID, NAME and status. Number formats can be stored using international prefix "+", international prefix "00" or local.

WARNING: THIS FUNCTION COULD NOT BE FREE OF CHARGE. DEPENDING ON YOUR OPERATOR CONTRACT IT COULD GENERATE PAYING SMS TRAFFIC !

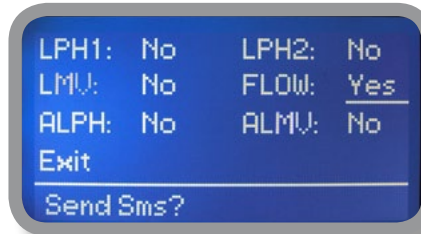

To enable warning message for related alarm condition choose "YES", to disable choose "NO". Then move wheel on Exit and SAVE configuration. **SMS will be sent when one or more ("YES") fields will change.**

LPH1 or 2 : level alarm for PH1 or PH2 levels

LMV: level alarm for ORP

FLOW: flow alarm

ALPH: out of reading range for pH probe

ALMV: out of reading range for ORP probe

WARNING: TO AVOID UNSOLICITED MESSAGES USE CAREFULLY THIS SETUP!

Appendix B - "USB data log module"

Located under mainboard cover there is a four pins connector that can be used to install "USB data log module" or "SMS module". Modules come pre-installed upon request and may appear different as shown (different configurations).

"USB data log module" records instrument activities. These information can be permanently stored into a standard USB pendrive. Pendrive can be connected to a PC using "LDPHxx DATA LOGGER" software to review and print instrument's activities. **To obtain reliable results with this feature please set instrument ID and NAME from "RS485 Setup" menu (see page 28) and activate log recording from "LOG SETUP" menu (see page 28).**

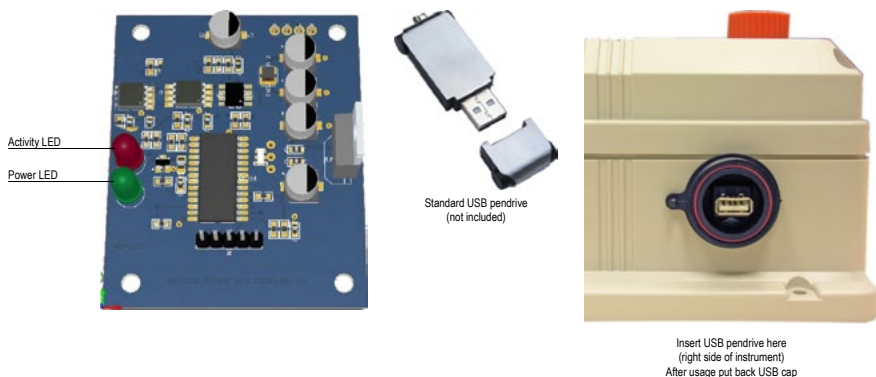

HOW TO RECORD INSTRUMENT'S ACTIVITIES INTO USB PENDRIVE ?

Insert USB pendrive into USB connector (located on the right side of instrument). Instrument will save data log on USB pendrive. After succeeded in saving data it will ask if delete instrument's log or not (anyway USB pendrive will not be formatted). Move wheel on "YES" to delete log info from instrument and return to main screen or "NO" to leave log info on instrument and return to main screen. **Wait about 30 seconds to safety remove the USB pendrive.**



HOW TO REVIEW INSTRUMENT'S ACTIVITIES RECORDED INTO USB PENDRIVE ?

It's necessary to install the "LDPHxx Data Logger" software to review USB pendrive info on a PC. Follow installation instructions during software setup to correctly complete this procedure. Once the "LDPHxx Data Logger" has been installed and launched insert your USB pendrive into any available USB connector of PC. Instrument's log will be automatically uploaded into PC memory. See "LDPHxx Data Logger" quick guide for more info.

Appendix C - Dimensions

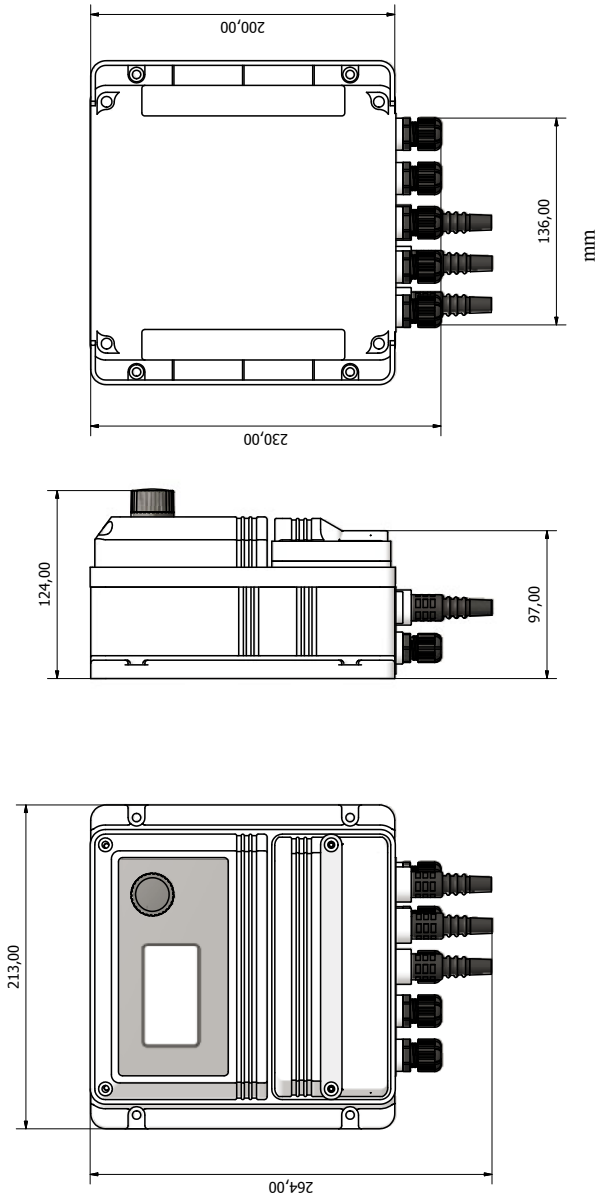

Index

1. Introduction	3
2. The wheel.....	3
3. Mainboard Connections.....	4
4. Main Screen	5
5. Quick status check.....	6
6. Password	7
7. "Main Menu" list	8
8. "Set-Point", pH working modes.....	9
8.1 "Set-Point", pH (on/off).....	9
8.2 "Set-Point", pH (on/off).....	10
8.3 "Set-Point", pH (proportional)	11
8.4 "PWM" (proportional), pH.....	12
8.5 "PWM" (fixed), pH.....	13
8.6 "Set-Point", ORP (On/Off).....	14
8.7 "Set-Point", ORP (on/off).....	14
8.8 "Set-Point", ORP (proportional)	15
8.9 "PWM" Proportional, ORP.....	16
8.10 "PWM" (fixed), ORP	17
9. "Probe Calibration", pH.....	18
9.1 "Probe Calibration", ORP	20
9.2 "Probe Calibration", °C - Temperature.....	21
10. "Parameters"	22
11. "Output Manager"	23
12. "Instrument Reset"	24
13. "Dosing Alarm"	25
14. "International"	26
15. "Probe Failure"	27
16. "Flow Contact"	28
17. "Service"	28
18. "Log Setup"	29
19. "RS485 Setup"	29
20. "mA Outputs"	30
21. "Out of range alarm"	31
22. Technical information.....	32
23. SEPR configuration	33
Appendix A - "SMS/GSM module"	34
Appendix B - "USB data log module"	35
Appendix C - Dimensions	36

Information on this manual may contain technical inaccuracies or typographical errors.
The information contained may be changed at any time without prior notification or obligation.



When dismantling this instrument please separate material types and send them according to local recycling disposal requirements.
We appreciate your efforts in supporting your local Recycle Environmental Program.
Working together we'll form an active union to assure the world's invaluable resources are conserved.